



G108-0001



ULTRA SLIMPAK® G108-0001

DC Powered DC Input Limit Alarm

Provides Relay Contact Closures
at a Preset DC Input Level



- Programmable HI or LO, Failsafe or Non-failsafe
- Field Configurable Input Ranges
- 24VDC Transducer Excitation
- LED Trip and Input Indicators
- Flexible Power Supply Accepts 9 to 30 VDC
- ASIC Technology for Enhanced Reliability
- RoHS Compliant

Description

The Ultra SlimPak G108 is a DIN rail mount, DC voltage or current input limit alarm with dual setpoints and two contact closure outputs. The field configurable input and alarm functions offer flexible setpoint capability. Input voltage spans from 10mV to 200V and input current spans from 1mA to 100mA can be field configured. Bipolar inputs are also accepted.

The G108 is configurable as a single or dual setpoint alarm, with HI or LO trips and failsafe or non-failsafe operation. Also included are adjustable deadbands (0.25 to 5% of full scale input) for each setpoint, a 24VDC voltage source (isolated from line power) for transducer excitation, and a flexible DC power supply which accepts any voltage between 9 and 30VDC.

Diagnostic LEDs

The G108 is equipped with three front panel LEDs. The dual function green LED is labeled INPUT and indicates line power and input signal status. Active DC power is indicated by an illuminated LED. If this LED is off, check DC power and the wiring connection. If the input signal is more than 110% of the full scale range, the LED will flash at 8 Hz. Below 0%, it flashes at 4 Hz. Two red LEDs indicate the relay state for each setpoint. An illuminated red LED indicates the tripped condition.

Output

The G108 is equipped with two SPDT (form C) relays, rated at 120VAC or 28VDC at 5 Amperes. Each of these relays is independently controlled by the field configurable setpoint and deadband.

Operation

The field configurable G108 limit alarm setpoints can be configured for HI or LO, failsafe or non-failsafe operation. Each of the setpoints has a respective HI or LO deadband. In a tripped condition, the setpoint is exceeded and the appropriate red LED will illuminate. The trip will reset only when the process falls below the HI deadband or rises above the low deadband (see Figure 1). For proper deadband operation, the HI setpoint must always be set above the LO setpoint. In failsafe operation, the relay is energized when the process is below the HI setpoint or above the LO setpoint (opposite for non-failsafe). In the failsafe mode, a power failure results in an alarm state output.

Dynamic Deadband

Circuitry in the G108 prevents false trips by repeatedly sampling the input. The input must remain beyond the setpoint for 100 milliseconds, uninterrupted, to qualify as a valid trip condition. Likewise, the input must fall outside the deadband and remain there for 100 milliseconds to return the alarm to an untripped condition. This results in a “dynamic deadband” (based on time) in addition to the normal deadband.

Configuration

Unless otherwise specified, the factory presets the Model G108 as follows:

Input:	Current
Range:	0-20mA
Output:	Dual, SPDT
Trip:	A:HI, B:LO
Failsafe:	No
Deadband:	A, B: 0.25%

The DC power input accepts any DC source between 9 and 30V. Typically a 12V or 24VDC source is used (see Accessories).

For other I/O ranges, refer to Table 1. Reconfigure switch SW1 for the desired input type, range and function.

1. With DC power off, set position 9 and 10 of SW1 for current or voltage (see Figure 4).
2. Set position 1 through position 4 of input range switch “SW1” for the desired input range (see Table 1).
3. Set position 5 of input range switch “SW1” to ON for unipolar (e.g. zero based, 0-20mA) range or OFF for bipolar (e.g. -100% offset, -20 to 20mA) range.
4. Set position 6 and 7 of input range switch “SW1” to ON for a HI trip setpoint or OFF for a LO trip setpoint.
5. Set position 8 of input range switch “SW1” to ON for non-failsafe operation or OFF for failsafe operation (e.g. alarm trips upon power failure).

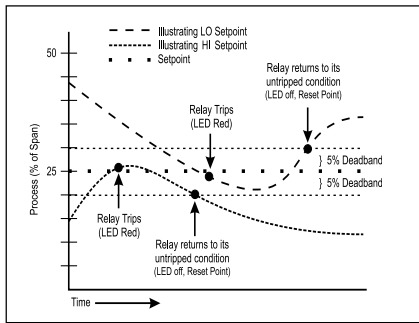

Figure 1: Limit alarm operation and effect of deadband.

Calibration

1. After configuring the DIP switches, connect the input to a calibrated DC source and apply power. Refer to the terminal wiring (Figure 7).

Note: To maximize thermal stability, final calibration should be performed in the operating installation, allowing approximately 1 to 2 hours for warm up and thermal equilibrium of the system.

2. Setpoint: Set deadband to its minimum (fully counterclockwise) before adjusting the setpoint. With the desired trip voltage or current input applied, adjust the setpoint until the relay trips. For HI trip calibration, start with the setpoint above the desired trip (full clockwise). For LO trip calibration, start below the desired trip (full counterclockwise).

3. Deadband: Set deadband to its minimum (fully counterclockwise). Set the setpoint to desired trip. Adjust the input until the relay trips. Readjust deadband to 5% (fully clockwise). Set the input signal to desired deadband position. Slowly adjust deadband until relay untrips.

Table 2: G108 Trip Settings

Function	Selector SW1			
	5	6	7	8
Unipolar			■	
Trip B HI			■	■
Trip A HI		■		
Non-Failsafe		■		■

Key: ■ = 1 = ON or Closed

Relay Protection & EMI Suppression

When switching inductive loads, maximum relay life and transient EMI suppression is achieved using external protection (see Figures 2 and 3). Place all protection devices directly across the load and minimize all lead lengths. For AC inductive loads, place a properly rated MOV across the load in parallel with a series RC snubber. Use a 0.01 to 0.1uF pulse film capacitor (foil polypropylene recommended) of sufficient voltage, and a 47 ohm, 1/2W carbon resistor. For DC inductive loads, place a diode across the load (PRV > DC supply, 1N4006 recommended) with (+) to cathode and (-) to anode (the RC snubber is an optional enhancement).

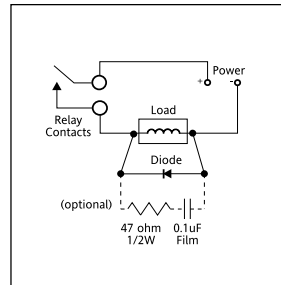

Figure 2: DC Inductive Loads

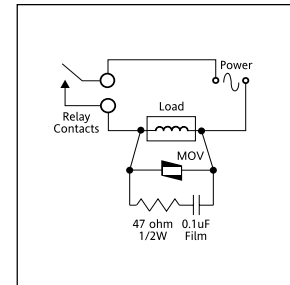

Figure 3: AC Inductive Loads

Table 1: G108 Input Range Settings

Ranges		Selector SW1					
Voltage	Current	1	2	3	4		
10mV	1mA			■			
20mV	2mA			■	■		
50mV	5mA		■				
100mV	10mA		■		■		
200mV	20mA		■	■			
500mV	50mA		■	■	■		
1V	100mA	■					
2V		■			■		
5V		■		■			
10V		■		■	■		
20V		■	■				
50V		■	■		■		
100V		■	■	■			
200V		■	■	■	■		
Input Type						9	10
Current							■
Voltage						■	

Key: ■ = 1 = ON or Closed

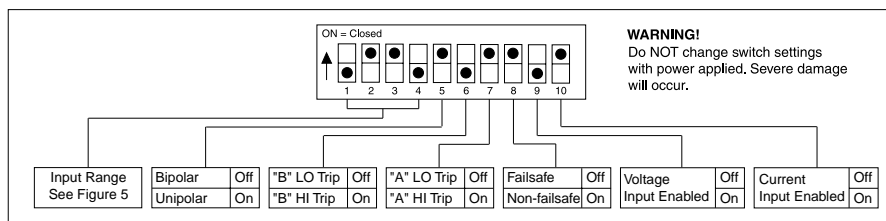

Figure 4: G108 Input Range/Function Selection (SW1) Factory Default Settings

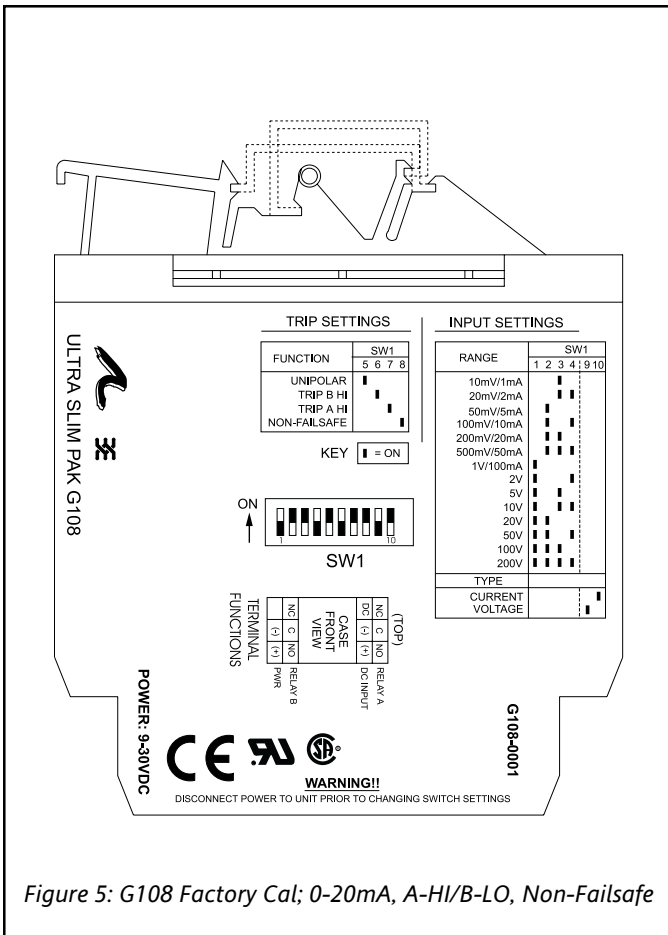

Figure 5: G108 Factory Cal; 0-20mA, A-HI/B-LO, Non-Failsafe

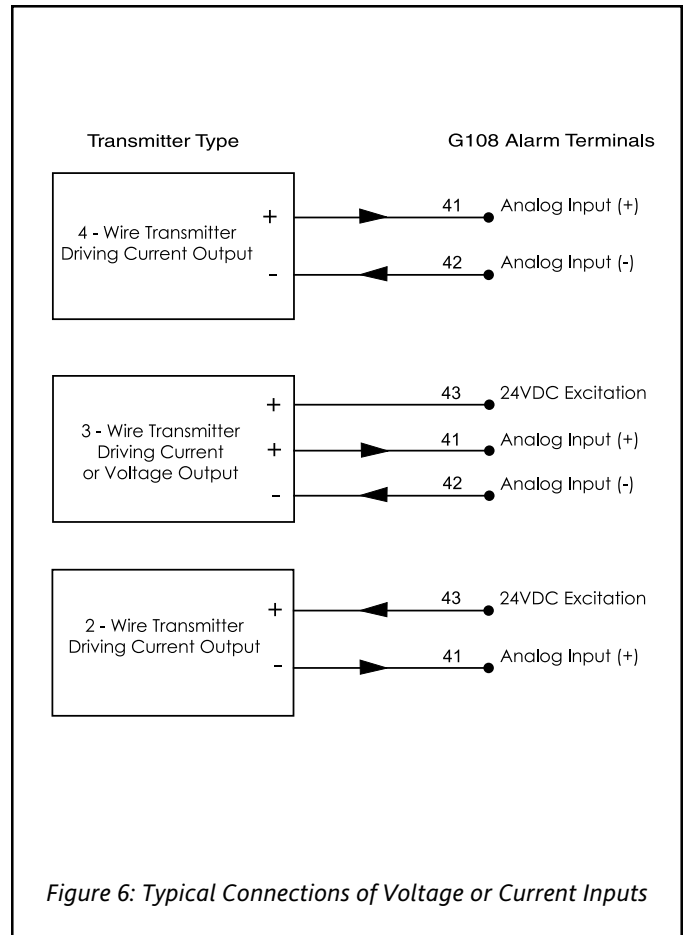

Figure 6: Typical Connections of Voltage or Current Inputs

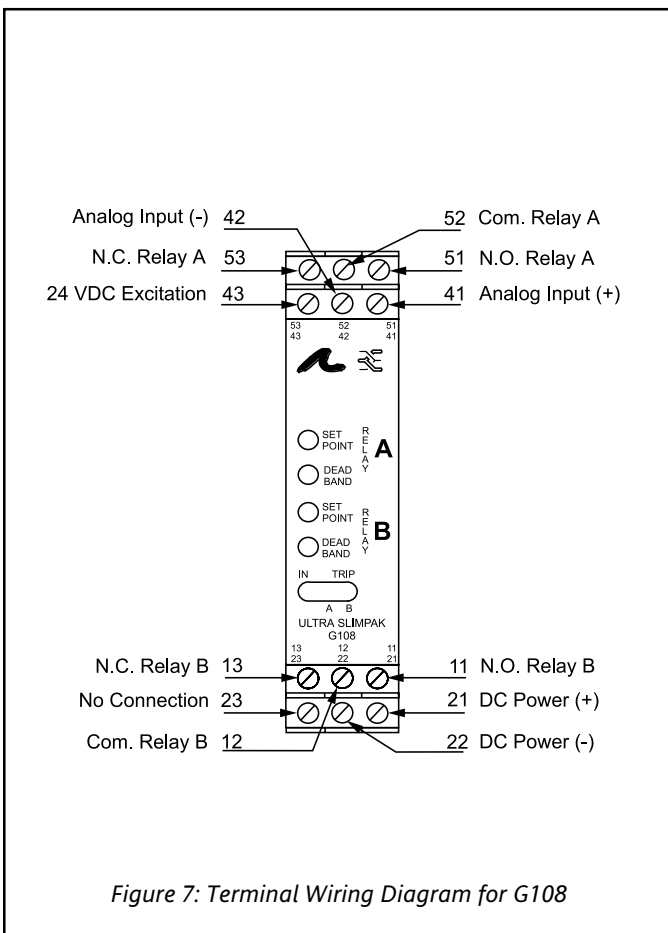
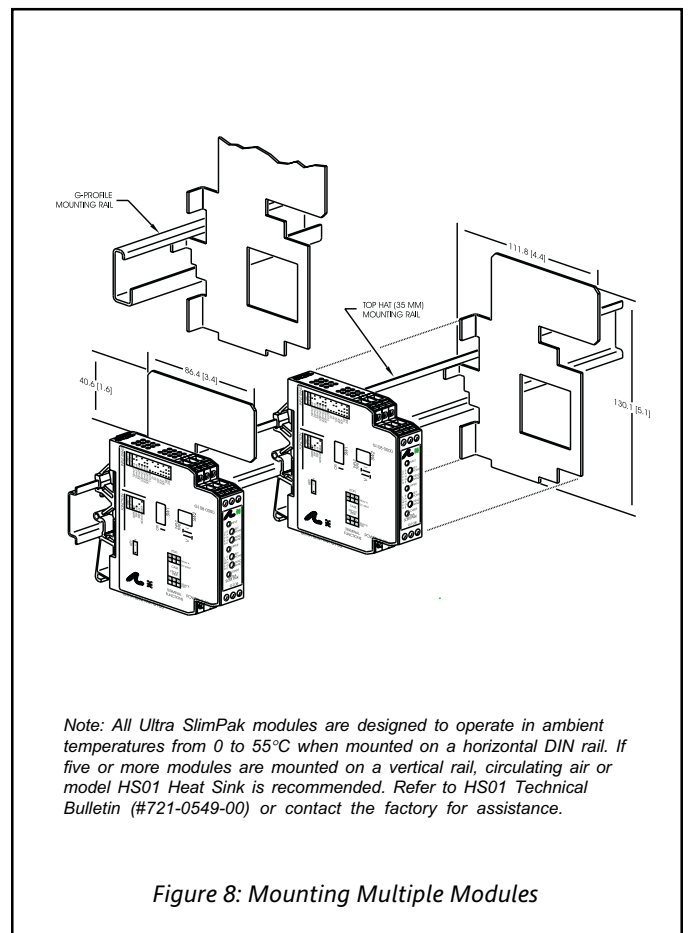

Figure 7: Terminal Wiring Diagram for G108



Note: All Ultra SlimPak modules are designed to operate in ambient temperatures from 0 to 55°C when mounted on a horizontal DIN rail. If five or more modules are mounted on a vertical rail, circulating air or model HS01 Heat Sink is recommended. Refer to HS01 Technical Bulletin (#721-0549-00) or contact the factory for assistance.

Figure 8: Mounting Multiple Modules

Specifications

Inputs

- Voltage
 - Range: 10mV to $\pm 200V$
 - Impedance: >100K ohms
 - Overvoltage: 200V rms, max.
- Current
 - Range: 1mA to $\pm 100mA$
 - Impedance: 20 ohms, typical
 - Overcurrent: 170mA rms, max.
 - Overvoltage: 60VDC (protected by self resetting fuse)
- Common Mode (Input to Ground):
 - 1800VDC, max.

LED Indicators

- Input Range (Green)
 - >110% input: 8Hz flash
 - <0% input: 4Hz flash
- Setpoint (Red)
 - Tripped: Solid red
 - Safe: Off

Limit Differentials (Deadbands)

- >50mV/5mA: 0.25% to 5% of span
- <50mV/5mA: 1% to 5% of span

Response Time

- Dynamic Deadband:
 - Relay status will change when proper setpoint/process condition exists for 100msec.
- Normal Mode (analog filtering):
 - <250mSec, (10-90%)

Setpoints

- Effectivity:
 - Setpoints are adjustable over 100% of the selected input span.
- Repeatability (constant temp.):
 - >50mV/5mA: 0.1% of full scale
 - <50mV/5mA: 0.2% of full scale

Stability

- Temperature: $\pm 0.05\%$ of full scale/ $^{\circ}C$, max.

Excitation Voltage

- 24VDC, 20mA, maximum

Common Mode Rejection

- DC to 60Hz: 120dB

Isolation

- 1800VDC between contacts, input & power

EMC Compliance (CE Mark)

- Emmissions: EN50081-1
- Immunity: EN50082-2
- Safety: EN50178

Humidity (Non-Condensing)

- Operating: 15 to 95% @45 $^{\circ}C$
- Soak: 90% for 24hours @65 $^{\circ}C$

Temperature Range

- Operating: 0 to 55 $^{\circ}C$ (32 to 131 $^{\circ}F$)
- Storage: -25 to 70 $^{\circ}C$ (-13 to 158 $^{\circ}F$)

Power

- Consumption: 1.5W typical, 2.5W max.
- Supply Range: 9 to 30VDC, inverter isolated

Relay Contacts

- 2 SPDT (2 form C) Relays
- 1 Relay per setpoint
- Current Rating (resistive):
 - 120VAC: 5A; 240VAC: 2A; 28VDC: 5A
- Material: Gold flash over silver alloy
- Electrical Life: 10^5 operations at rated load
- Note: External relay contact protection is required for use with inductive loads (see Figures 2 & 3).*
- Mechanical Life: 10^7 operations

Wire Terminations

- Screw terminations for 12-22 AWG

Weight

- 0.56lbs.

Agency Approvals

- UL recognized per standard UL508 (File No.E99775)
- CE Conformance per EMC directive 89/336/EEC and Low Voltage 73/23/EEC (Input < 75VDC, only).
- RoHS Compliant

Ordering Information

Models & Accessories

Specify:

1. Model: **G108-0001**
2. Accessories: (see Accessories)
3. Optional Custom Factory Calibration; specify **C620** with desired input and output range.

Accessories

SlimPak "G" series modules will mount on standard TS32 (model MD02) or TS35 (model MD03) DIN rail. In addition, the following accessories are available:

- HS01** Heatsink (vertical rail applications)
- MD03** TS35 x 7.5 DIN rail
- WV905** 24VDC Power Supply (0.5A)
- H910** 24VDC Power Supply (1A)
- H915** 24VDC Power Supply (2.3A)
- MB03** End Bracket for MD03
- C664** I/O Descriptive Tags
- C006** Shunt Resistor (0.1 ohm, 5A max.)

Dimensions

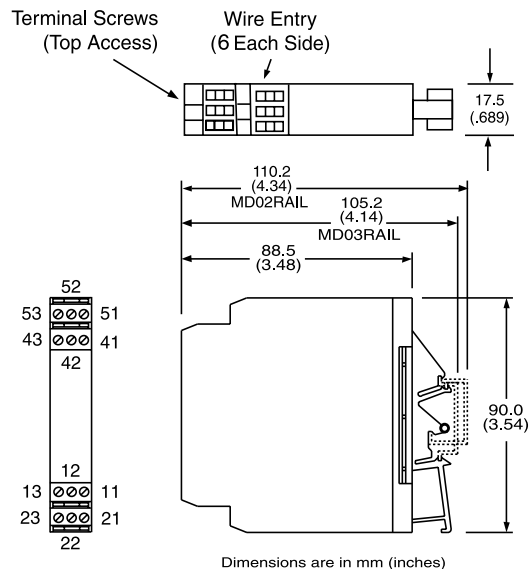

Factory Assistance

For additional information on calibration, operation and installation contact our Technical Services Group:

703-669-1318

actionsupport@eurotherm.com

721-0648-00-H 02/09 Copyright© Eurotherm, Inc 2009

Eurotherm, Inc

741-F Miller Drive
Leesburg, VA 20175-8993
703-443-0000

info@eurotherm.com or www.eurotherm.com/actionio